

# Nakamichi 670ZX

Discrete Head Cassette Deck

**Owner's Manual**

## **WARNING**

TO PREVENT FIRE OR SHOCK  
HAZARD, DO NOT EXPOSE  
THIS APPLIANCE TO RAIN OR  
MOISTURE.

Please record the Model Number and Serial Number in the space provided below and retain these numbers.

Model Number and Serial Number are located on the rear panel of the unit.

Model Number : Nakamichi 670ZX

Serial Number : \_\_\_\_\_

## **CONTENTS**

Safety Instructions .....	1
Controls and Features .....	3
Precautions .....	5
Connections .....	6
Playback .....	7
Recording .....	8
Special Features .....	11
Recommended Tape .....	15
Record Head Auto Azimuth Alignment and Record Calibration .....	17
The Dolby System .....	19
Maintenance .....	21
Troubleshooting .....	23
Specifications .....	24

Congratulations!

You have chosen one of the most advanced cassette decks on the market today. The 670ZX is the latest in a long line of Nakamichi audio components and built to deliver the utmost in quality and performance.

It features history-making technology, such as the discrete 3-head configuration, diffused resonance transport, and DC recording amplifier as well as functions such as the auto azimuth alignment mechanism.

The 670ZX is capable of taking full advantage of the recently developed pure metal particle tape.

Last, but not least, the 670ZX incorporates a sophisticated micro-processor which provides random access capability.

Nakamichi products are internationally famous for state-of-the-art engineering and manufacture - assurance that your 670ZX will bring you many years of reliable service and enjoyment.

Many of the 670ZX's controls and features may be unfamiliar to you at the moment. This manual has been designed to acquaint you with the 670ZX in the shortest possible time. Please take the time to read it in its entirety.

Thank you.

Nakamichi Corporation

# Safety Instructions

The following safety instructions have been included in compliance with safety standard regulations. Please read them carefully.

1. **Read Instructions** - All the safety and operating instructions should be read before the appliance is operated.
2. **Retain instructions** - The safety and operating instructions should be retained for future reference.
3. **Heed Warnings** - All warnings on the appliance and in the operating instructions should be adhered.
4. **Follow Instructions** - All operating and use instructions should be followed.
5. **Water and Moisture** - The appliance should not be used near water - for example, near a bathtub, washbowl, kitchen sink, laundry tub, in a wet basement, or near swimming pool, etc.
6. **Carts and Stands** - The appliance should be used only with a cart or stand that is recommended by the manufacturer.
7. **Wall or Ceiling Mounting** - The appliance should be mounted to a wall or ceiling only as recommended by the manufacturer.
8. **Ventilation** - The appliance should be situated so that its location or position dose not interfere with its proper ventilation. For example, the appliance should not be situated on a bed, sofa, rug, or similar surface that may block the ventilation openings; or placed in a built - in installation, such as a bookcase or cabinet that may impede the flow of air through the ventilation openings.
9. **Heat** - The appliance should be situated away from heat sources such as radiators, heat registers, stoves, or other appliance (including amplifiers) which produce heat.
10. **Power Sources** - The appliance should be connected to a power supply only of the type described in the operating instructions or as marked on the appliance.

11. Grounding or Polarization - Precautions should be taken so that the grounding or polarization means of an appliance is not defeated.
12. Power-Cord Protection - Power-supply cords should be routed so that they are not likely to be walked on or pinched by items placed upon or against them, paying particular attention to cords at plugs, convenience receptacles, and the point where they exit from the appliance.
13. Cleaning - The appliance should be cleaned only as recommended by the manufacturer.
14. Nonuse Periods - The power cord of the appliance should be unplugged from the outlet when left unused for a long period of time.
15. Object and Liquid Entry - Care should be taken so that objects do not fall and liquids are not spilled into the enclosure through openings.
16. Damage requiring Service - The appliance should be serviced by qualified service personnel when:
  - A. The power-supply cord or the plug has been damaged; or,
  - B. Objects have fallen, or liquid has been spilled into the appliance; or,
  - C. The appliance has been exposed to rain; or,
  - D. The appliance does not appear to operate normally or exhibits a marked change in performance; or,
  - E. The appliance has been dropped, or the enclosure damaged.
17. Servicing - The user should not attempt to service the appliance beyond that described in the operating instruction. All other servicing should be referred to qualified service personnel.

# Controls and Features

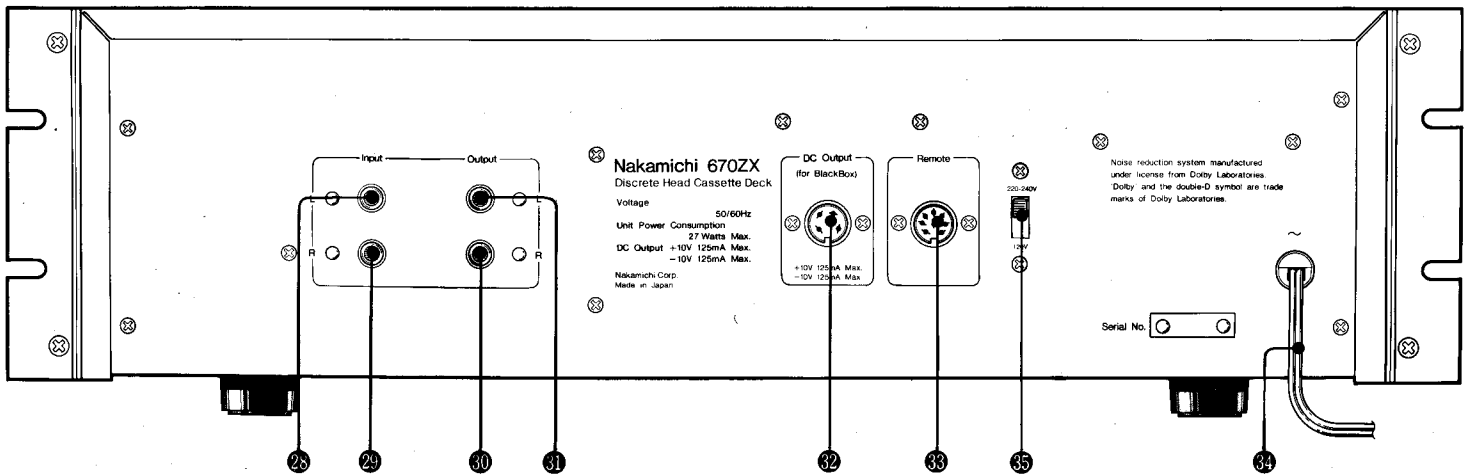
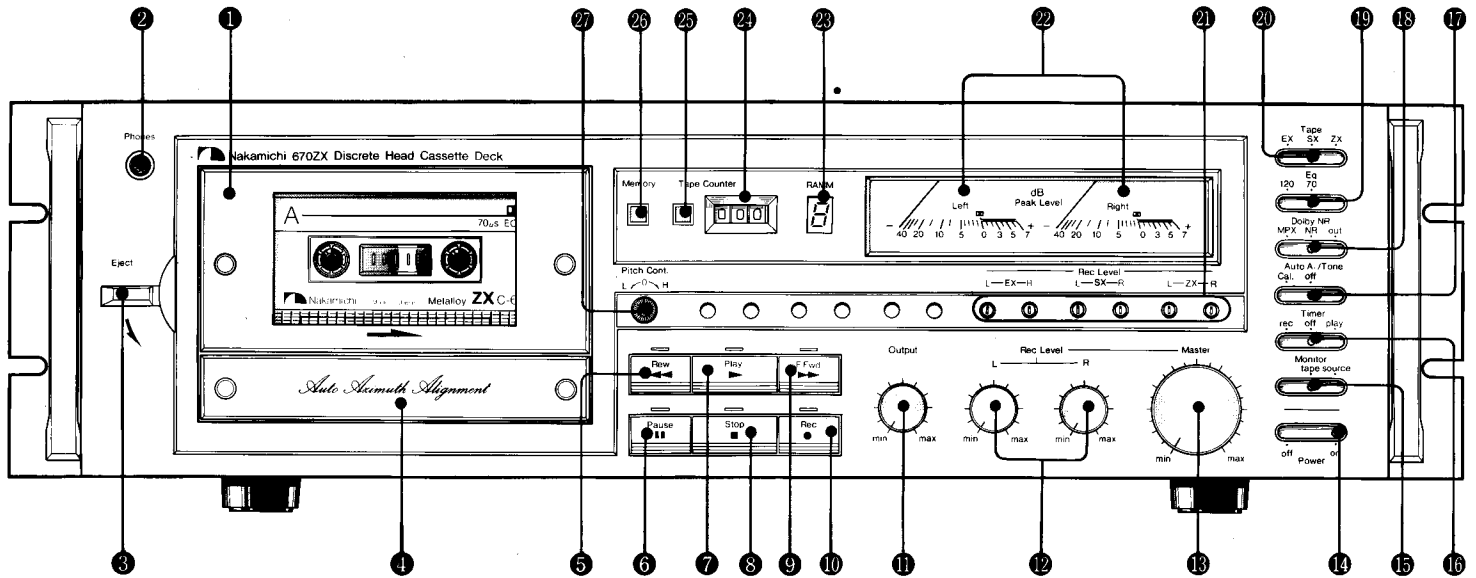

## (1) Cassette Holder (with see-thru cover)

Ensures proper alignment of cassette for insertion into compartment. See-thru cover provides an unobstructed view of the cassette. The cover can be easily removed for routine maintenance (page 21).

## (2) Headphone Jack

Accepts standard stereophonic plug.

## (3) Eject Lever

Press down to open the cassette compartment. An interlock mechanism prevents operation of this lever when the transport is in any mode other than "stop".

## (4)

In normal use, this cover should not be removed. Adjusting screws such as head height and azimuth alignment screws are provided inside cover. These screws have been finely adjusted at the factory for optimum performance. **DO NOT ATTEMPT RE-ADJUSTMENT.**

## (5) Rewind Button

For rapid tape-winding in the reverse direction.

## (6) Pause Button

Used for noise-free, short-term stopping of the tape in the record or play mode. Also used to activate the cueing and program search modes during fast-forward or rewind. See page 11.

## (7) Play Button

Starts forward tape motion at controlled speed for recording or playback.

### (8) Stop Button

Brings all tape motion to a full stop from any mode. This is the only mode in which the head assembly is fully retracted.

### (9) Fast-Forward Button

For rapid tape-winding in the forward direction.

### (10) Record Button

Puts the 670ZX into the record mode. Must be used in conjunction with the pause or play button (page 8). Also used to decrease the "count" in the program search mode (page 12).

### (11) Output Level Control

Controls the output level of the 670ZX during record and playback. Also controls headphone listening volume. Controls the left and right channels simultaneously. Has no effect on input (record) signals.

### (12) Input Level Controls (Left Channel and Right Channel)

### (13) Master Input Level Control

Controls the input (record) levels for the left and right channels simultaneously. After level and balance have been preset with the individual input level controls (12), this control can be used for "fading in" or "fading out" the program source.

### (14) Power Switch

Activates the 670ZX. The level meters and the cassette compartment will illuminate to indicate that power is "on".

### (15) Monitor Switch

Selects either the input signal ("source") or the playback signal ("tape") for monitoring during record. This switch must be in the "tape" position for playback.

### (16) Timer Switch

Programs the 670ZX for unattended recording or playback when used with an external timer. See page 11. Must be in the "off" position when the timer function is not in use.

### (17) Auto. A/Tone Switch

For record head auto azimuth alignment and record calibration, this switch is to be set to the "Cal" position. This position also serves as a switch for the built-in 400Hz test tone used for adjustments. See page 17. Set this switch to the "off" position for normal recording and playback.

### (18) Dolby NR/MPX Filter Switch

Activates Dolby Noise Reduction circuitry, which reduces tape hiss by as much as 10dB when used during record and playback. The "MPX" position additionally engages a 19KHz filter to remove any residual FM multiplex carrier signal. The MPX filter should be engaged when recording FM stereo broadcasts in order to keep the 19kHz carrier signal from interfering with proper functioning of the Dolby circuits.

### (19) Eq Switch

Selects either 120 or 70 microsecond equalization. Proper record and playback equalization is essential for optimum performance with each tape type. See page 15 for a detailed explanation.

### (20) Tape Switch

Selects required record sensitivity and bias level for three different tape types: EX (low-noise/high-output ferric oxide), SX (chrome-equivalent), and ZX (metal particle).

### (21) Record Calibration Controls

Screwdriver adjustments for record level calibration, essential for proper tracking of the Dolby Noise Reduction circuits. These controls are adjusted using the built-in 400Hz test tone. See page 17.

### (22) Peak Level Meters

Indicate peak program levels from -40 to +7dB.

### (23) RAMM Display

The 670ZX Random Access Music Memory (RAMM) system uses a micro-processor to assist you in the location of specific points on a recorded tape. It does so by actually "counting" the selections. The RAMM Display indicates the activation of the program search mode and the number of selections left to skip before arriving at the desired program. See page 12 for programming details.

### (24) Tape Counter

Indicates relative position of the tape. May be used to index selections on the tape.

### (25) Counter Reset Button

Resets the tape counter to 000 when fully depressed.

### (26) Tape Start Memory Switch

The memory feature provides a handy method of re-locating any given starting point on the tape. With the memory switch engaged and the tape counter set to 000 at the desired point, the 670ZX will automatically stop from the rewind mode when the counter reaches 999.

### (27) Pitch Control

Controls tape speed during playback over a range of  $\pm 6\%$ . Leave this control in the center detented position when normal speed is desired. Has no effect on tape speed during record.

### (28) Input Jack (Left Channel)

### (29) Input Jack (Right Channel)

### (30) Output Jack (Right Channel)

### (31) Output Jack (Left Channel)

### (32) DC Output Jack

Provides a regulated  $\pm 10$  Volts DC to power one or more of Nakamichi's BlackBox Series components, such as the MX-100 Microphone Mixer. Total current consumption of BlackBox Series components powered from this jack must not exceed 125mA. See page 13.

### (33) Remote Control Socket

The optional remote control is plugged into this sockets.

### (34) Power Cord

### (35) Voltage Selector

AC Voltage is factory set for the country in which you purchased your 670ZX. The Voltage Selector permits re-setting of mains voltage in case the deck is to be used in a different country.

Note:

Safety regulations in certain countries prohibit inclusion of a voltage selector. This feature, therefore, may be absent from your deck.

# Precautions

1. Do not install the 670ZX close to heat sources (such as radiators), or in a place subject to direct sunlight, excessive dust or moisture.
2. Make sure the timer switch (16) is set to "off" when you do not desire the self-starting feature. Should this switch be accidentally left in the "rec" position, you will begin recording merely by turning on the power switch. A cassette already in the compartment and without its protective tabs removed will be erased in such instances. Although this may be an unlikely occurrence, you can eliminate the possibility of such accidental erasure by observing this precaution.
3. Make sure the Auto. A/Tone switch (17) is set to "off" during normal recording or playback.
4. The 670ZX's head assembly is at the bottom of the cassette compartment. The cassette, therefore, must be inserted with the exposed tape down. (Nakamichi 1000 owners note!) Inserting the cassette upside down, and consequently forcing the lid shut may cause serious damage to the cassette and the 670ZX.
5. Use of loose tape for recording and playback will ordinarily cause jamming of tape. However, this deck incorporates a special circuit designed to take up any loose tape inside the cassette when it is inserted. The moment you push the cassette holder into the compartment, the take-up spindle will rotate several times while the supply spindle is held stationary. This behavior is normal and not a fault with the deck.



# Connections

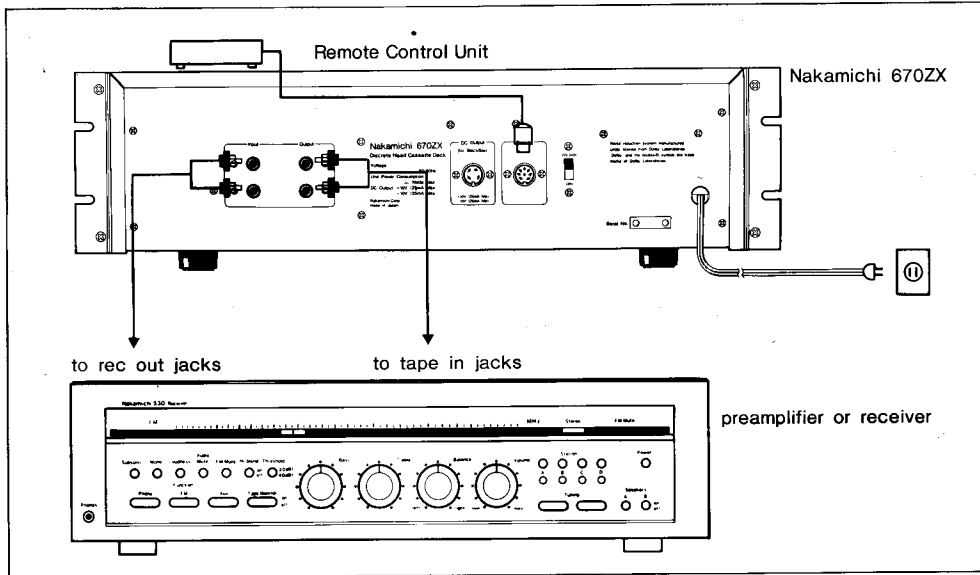

## Power Connections

Connect the AC power cord (34) to a nearby wall outlet or an auxiliary AC outlet on one of your other components. The 670ZX has a rated maximum power consumption of 27 Watts. Check the power rating of the AC outlet you are using to make sure you are not exceeding its capacity. If you are using your 670ZX in a country other than the one in which the deck was purchased, you must make sure that the local AC voltage is compatible. Consult a local audio dealer if you are unsure.

## Audio Connections

There are two ways of connecting the Nakamichi 670ZX to your preamplifier, amplifier or receiver. You may use shielded cables with RCA plugs (provided with the deck) to connect the left and right input jacks (28, 29) to the "rec" or "tape out" jacks on your preamplifier. In the same way, connect the output jacks (30, 31) to the "tape in", "tape mon", "tape PB" or "aux in" jacks of your preamplifier.

## Headphones

Standard stereo headphones may be connected to the headphone jack (2) on the 670ZX's front panel. Low impedance headphones (8 ohms nominal) are recommended.

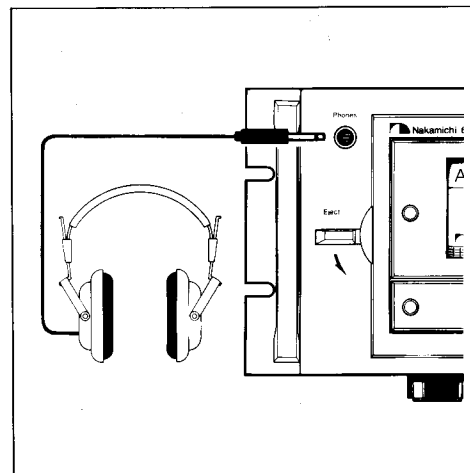

## DC Output Jack

The DC output jack (32) on the rear panel of the 670ZX provides a regulated  $\pm 10$  Volts DC supply expressly for the purpose of powering one or more of Nakamichi's BlackBox Series components. Use the DC power cord supplied with each BlackBox unit to connect the DC output jack of the 670ZX to the DC input jack of the BlackBox unit. See the section entitled "Special Features" (page 13) for more information on the BlackBox Series.

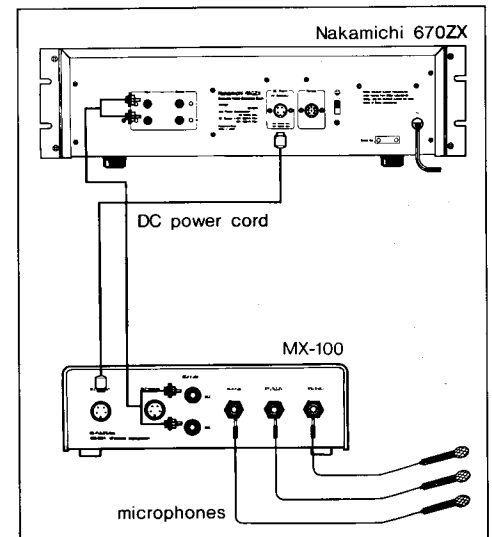

## Remote Control

The optional remote control is plugged into the 670ZX's remote control socket (33). Consult the directions included with the Remote Control for operating details.

# Playback

- (A) Make sure the volume control on your amplifier or receiver is turned down. Then, turn the 670ZX's power "on" using the power switch (14).

The cassette compartment and peak level meters will illuminate if power connections have been properly made.

- (B) Open the cassette compartment by pushing down on the eject lever (3).  
 (C) Load the cassette into the holder (1) from the top. Make sure the exposed tape is facing down and the label of the desired side is facing you.

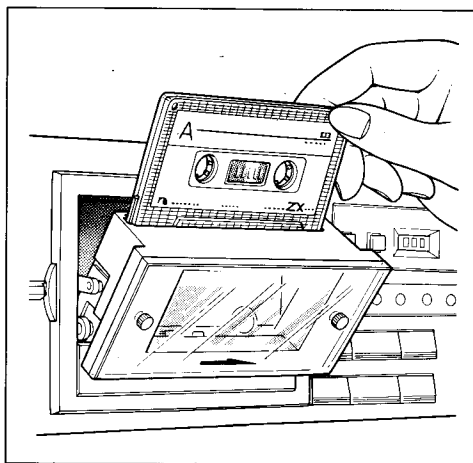

- (D) Push the cassette holder (1) gently back into the panel.  
 (E) Set the Eq switch (19) to the required position—either 120 or 70 microseconds. See page 15 for details. The tape switch (20) has no effect whatsoever on playback.  
 (F) Confirm that the Auto. A/Tone switch (17) is positioned to "off".  
 (G) If the tape was recorded with the Dolby system, set the Dolby NR switch (18) to the "NR" position.  
 (H) Set the monitor switch (15) to the "tape" position.  
 (I) Set the output level control (11) in the vicinity of 2 o'clock. (This may be later changed to suit your listening requirements.)  
 (J) Press the play button (7) to start the tape.

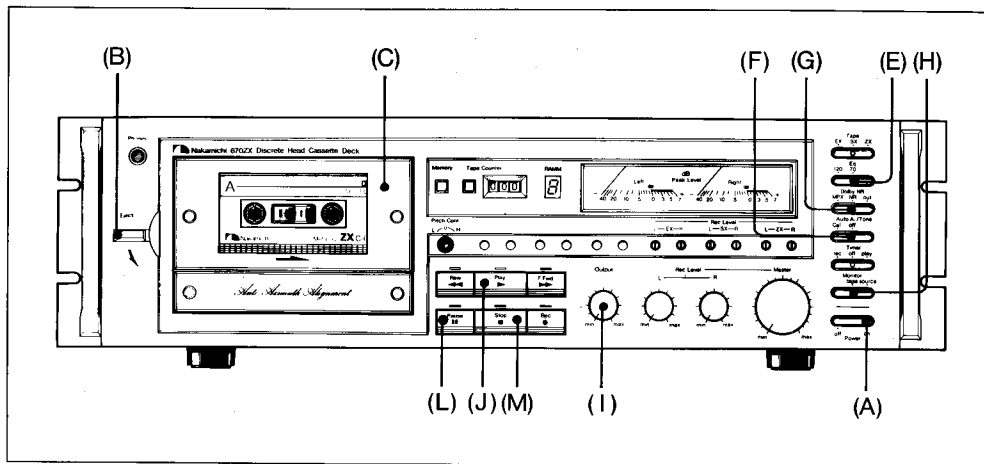

- (K) Slowly turn up the volume control on your amplifier or receiver to the desired listening level.  
 (L) To stop the tape momentarily, press the pause button (6). To resume playback, press the play button (7) again.  
 (M) To stop the tape altogether, press the stop button (8). After the tape has stopped, you may eject it by pushing the eject lever (3) down.

— It is possible to manually "cue up" a selection on the tape or to have the deck automatically search for a desired selection using the cueing and RAMM features built into the 670ZX. See the section entitled "Special Features" (page 11) for instructions.

## Note:

- You cannot eject the cassette while the tape is in motion.
- When the tape reaches its end, or if a defect within the cassette impedes tape motion, the 670ZX's logic circuitry will automatically return the transport to the stop mode.
- Logic circuitry prevents operation of the transport when the cassette holder is out of its compartment.
- You need not press the stop button when going from one transport mode to another (e.g. from rewind to fast-forward).
- During playback, the peak level meters (22) display the level of the signals on the tape. The output level control (11) will affect volume, but it will have no effect on level meters readings.

- (A) Prepare the desired program source, be it phono, tape or FM, by selecting the proper input with your amplifier or receiver. If you are making a "live" recording, connect the output of your microphone mixer (such as the Nakamichi MX-100) to the input of the 670ZX.
- (B) Turn the power switch (14) "on". The cassette compartment and peak level meters will illuminate to indicate power.
- (C) If you are taping one of the input sources connected to your amplifier or receiver, make the appropriate "tape monitor" or "tape play" selection on the amplifier and turn the volume control up to normal listening level.
- (D) Open the cassette compartment by pushing down on the eject lever (3).
- (E) Load the cassette into the holder (1) from the top. Make sure the exposed tape is facing down and the label of the desired side is facing you. Close the cassette compartment by gently pushing the holder back into the panel.
- (F) Set the Eq and tape selector switches (19, 20) as required. See page 15 for details. If you are using an unfamiliar brand of tape, we recommend that you check the record level calibration before proceeding any further. (See page 17 for calibration procedure.)
- (G) Set the Dolby NR switch (18) to "NR" unless you have a specific reason for not using Dolby Noise Reduction. Because Dolby decoding will be required for proper playback, be sure to make a note on the cassette label that the tape is Dolby-encoded.
- (H) If your program source is FM stereo, set the Dolby NR switch (18) to "MPX". Leakage of the 19kHz multiplex carrier from your tuner may otherwise cause erratic behavior of the Dolby circuits.
- (I) Press the tape counter reset button (25). The tape counter (24) should now read 000.

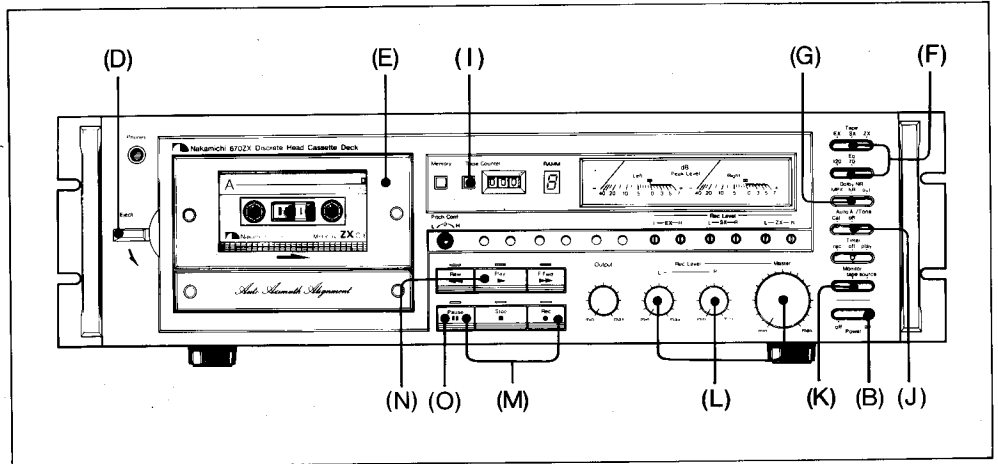

- (J) Confirm that the Auto. A/Tone switch (17) is positioned to "off".
- (K) Set the monitor switch (15) to "source".
- (L) You are now ready to set the input (record) levels. Turn the Master input level control (13) to approximately 2 o'clock. Use the individual input level controls while playing a portion of your program source to obtain the proper record levels for each channel. The right knob controls the right channel, and the left knob controls the left channel. See the section entitled "Tips on Setting Record Levels" (page 9) for more detailed information.
- (M) To put the 670ZX into the record/stand-by mode, press and hold the record button (10); while holding this button, press the pause button (6). When the red lamp above the record button comes on, release both buttons.
- (N) To commence recording, press the play button (7).
- (O) To stop the tape momentarily, press the pause button (6). Press the play button (7) again when you are ready to resume recording.
- (P) To stop recording altogether, push the stop button (8). When you have completed recording an FM stereo broadcast, remember to return the Dolby NR/MPX Filter switch (18) to its normal position.

- (Q) If you wish to check the quality of a recording in progress, you can monitor the playback signal by setting the monitor switch (15) to "tape".

## Cassette Tabs

You can protect valuable recordings from accidental erasure and re-recording by completely removing the appropriate tab on the top edge of the cassette. The tab for each side is located on the top-left-hand corner as you face the side. Use a small screwdriver, and push the tab down to break it off. Do not leave the broken tab in the recess. If you wish at a later date to record over a side for which the tab has been removed, cover the tab opening with a piece of adhesive tape.

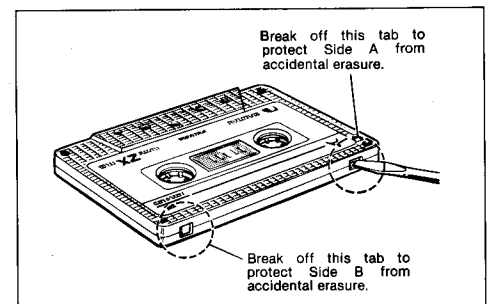

### Tips on Setting Record Levels

The proper setting of record levels requires practice and patience. Setting the level too high will result in tape saturation, which is audible as a grossly distorted recording. Low recording levels result in unacceptably noisy recordings because there is not enough of the signal on the tape to overcome the "hiss". Record level indicators vary in their effectiveness, but even the best indicator system is not totally foolproof. It takes experience to know just how much signal one can put on the tape. The best setting will be determined by the type of tape in use, the type of source material to be recorded and, to some degree, personal preferences of the user (some are willing to sacrifice signal-to-noise ratio for the totally distortion-free recording while others are willing to tolerate occasional tape saturation for quieter recordings).

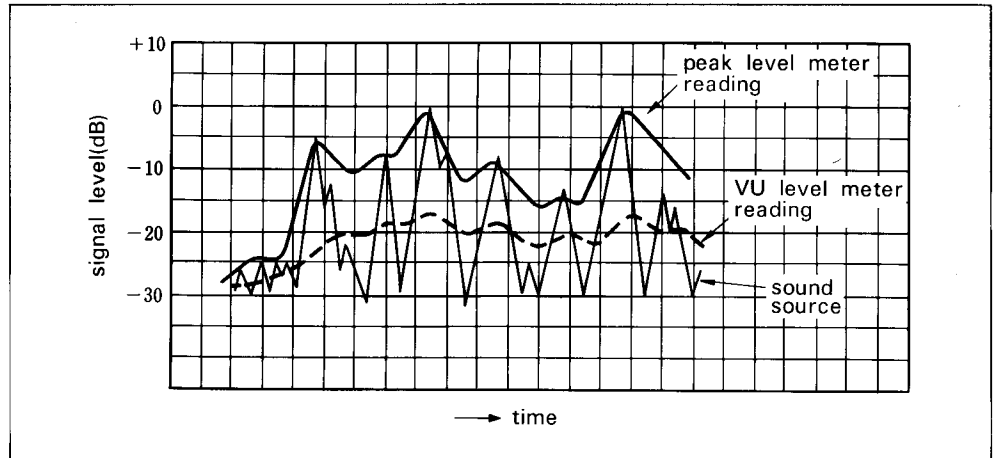

The fast-acting peak-level meters of the Nakamichi 670ZX are more accurate than the so-called VU meters found on most cassette decks. Conventional meters are not fast enough to give accurate indications of musical peaks. The illustration shows that there can be as much as 18dB difference between a peak-reading meter and a conventional meter on a transient signal, even though the two meters give the same reading on a continuous signal.

As a guide, begin by setting the record levels so that the meters occasionally "peak" into the red region above 0dB on a loud portion of the signal source. Brief excursions as high as +4 to +5dB generally do not result in noticeable saturation. If the needles stay above 0 dB for long periods, however, you are almost certainly producing an unacceptably distorted recording. You can, of course, check whether the levels have been correctly set by making a brief sample recording of the loudest passages and listening carefully while playing it back. This is only possible, however, your source is pre-recorded material, such as an LP record or another tape.

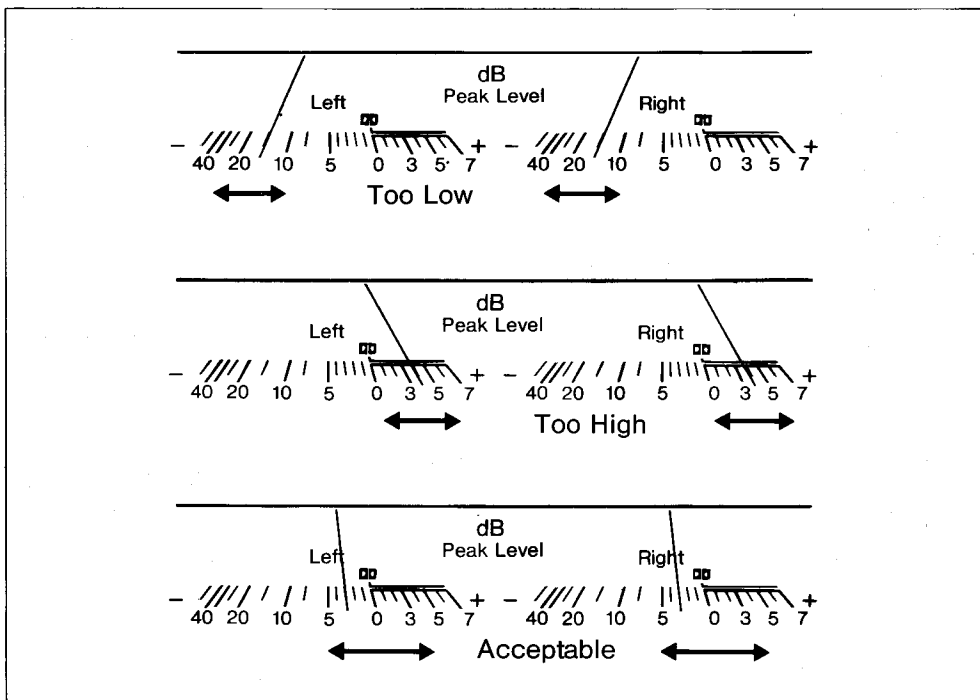

## Recording on Metalloy Tape

The Nakamichi 670ZX is one of the first cassette decks on the market with the ability to take advantage of the latest development in magnetic recording: the metal particle or metal alloy (metalloy) tape. Metalloy cassette formulations are capable of storing several times the magnetic energy encountered on the best of conventional oxide tapes. The 670ZX provides radically new erase and record head designs which are capable of handling the increased bias requirement of metalloy. In practice, metalloy tapes offer 3-4 dB additional headroom at midrange frequencies and 8-12 dB improvement at higher frequencies when compared to chrome-equivalent cassettes. Metalloy also provides reduced harmonic distortion and noise when used with an advanced deck like the 670ZX. You will find that metalloy tapes can be "pushed" a little further than conventional tapes; in other words, you can record at slightly higher levels with metalloy tape than you can with conventional tape.

Most users will find the performance of the 670ZX with conventional tapes more than satisfactory for their applications. The added capabilities of metalloy is best reserved for special applications, such as live recording or copying from studio-quality "master" tapes.

# Special Features

## Tape Start Memory

The memory switch (26) and the tape counter (24) work in conjunction to provide a handy method of re-locating any starting point on the tape. Whether you are recording or playing back, press the counter reset button (25) at any point on the tape if you think you will want to return to that point. By pressing the counter reset button, you will ensure that the tape counter will begin from 000. Later in the tape, when you want to return to your starting point, simply depress the memory switch (26) and press the rewind button (5). The transport will automatically stop at a counter reading of 999.

## Timer Operation

The 670ZX has a built-in self-start feature which enables you to make unattended recordings. This feature can also be used to have the 670ZX begin playing a cassette at a pre-selected time of day. To take advantage of this feature, you must use a timer, such as the Nakamichi DS-200 Digital Program Timer. An ordinary appliance timer can also be used, although this type of timer generally does not allow you to precisely set starting time.

Plug the AC power cord of the 670ZX into an AC outlet on the timer. Any other component which is to be turned on at the same time as the 670ZX, such as a tuner or receiver, must also be plugged into the timer. If the timer provides only one outlet, use it for the tuner or receiver, and plug the 670ZX's power cord into one of the outlets on the rear of the tuner or receiver. With the system's power "on" load a cassette into the 670ZX, and make all necessary level adjustments (record levels for unattended recording, volume levels for automatic playback). Then, set the timer for the desired starting time. Make sure all the necessary power switches are "on".

Set the timer switch (16) to the "play" or "rec" position, depending on whether you desire unattended playback or record, respectively. At the pre-selected time of day, the timer will turn on your system, and the 670ZX will begin playing or recording.

Make sure you return the timer switch to its "off" position when you have finished using the self-start feature. In particular, take care not to leave this switch in the "rec" position. You may, otherwise, inadvertently erase a cassette left in the 670ZX the next time you turn on your system.

## Cueing

When the tape is shuttling during rewind or fast-forward, the head assembly is normally retracted and the output muted so that you do not hear the unwanted, high-pitched sounds that would otherwise result. But these high-pitched signals, if somewhat reduced in speed, can be used to locate the blank spots which mark the end of one selection and the beginning of the next. Most professional, open-reel tape decks offer just such a feature. It is called cueing.

The 670ZX provides a unique feature quite similar to cueing systems found on professional equipment. While you are in rewind or fast-forward, you can hear the tape in high-speed motion by pressing the pause button (6). Pressing this button while the deck is fast-winding will move the playback head closer to the tape and reduce winding speed to one-third.

You can further reduce winding speed (to approximately one-fifth) by pressing and holding the rewind or fast-forward button (5, 9).

You will remain in the cueing mode until you press the stop button (8) or the play button (7).

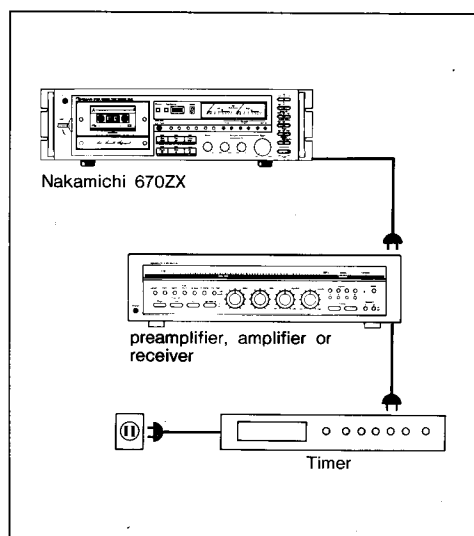

## Random Access Music Memory (RAMM)

The cueing feature described above enables you to listen for silent spaces between program selections in rewind or fast-forward to quickly locate the desired point on the tape. The RAMM program search system built into the 670ZX takes things a step further. Basically, with RAMM all you need to do is enter the number of selections you want to skip. The 670ZX does the rest automatically.

RAMM is activated and controlled using the pause (6), record (10), rewind (5) and fast-forward (9) buttons. This system may seem complicated at first, but it can be easily mastered with a little practice. By using the existing keyboard for RAMM, we have made it possible to perform program search functions via any of the 670ZX's optional remote controls, should you so desire.

1. Keep in mind the fact that the RAMM system senses and counts silent spaces between selections, decide how many selections you want to advance. Depress the fast-forward button (9) and then promptly press the pause button (6) once. This will activate the cueing mode.
2. As soon as the tape starts to run in the cueing mode, press the pause button (6) a second time. The numeral "1" should appear on the RAMM display (23) located to the left of the peak level meters.
3. If you want the system to find the beginning of the next selection, hold the numeral of the RAMM display at "1".

After following step 2, if you wish to skip a certain number of selections, press the pause button (6) to increase the RAMM count. The RAMM count will increase by one, every time you press the pause button, and the RAMM display will

show the count. You can increase the RAMM count to a maximum of "9". With the numeral of "2" showing, the system is programmed to skip the next selection and go to the beginning of the following selection. With the numeral of "3" showing, the system is programmed to skip the next two selections and go to the beginning of the third selection.

Should you wish to decrease the count for any reason, you can do so using the record button (10).

4. The program search system will wind the tape to the beginning of the programmed selection while counting selections. As the tape winds, you will notice the RAMM display counting down the selections as they go by. When the system arrives at the beginning of the desired selection, the RAMM count will be "0", and the 670ZX will automatically switch into the playback mode.

The steps above describe the procedure for advancing the tape to the desired selection. The RAMM system, however, works equally well in reverse. In order to find an earlier selection, merely press the rewind button instead of the fast-forward button in step 1. You can even change the winding direction in mid-search by pressing the rewind or fast-forward button. Should you wish to interrupt the RAMM mode at any time, simply depress the stop or play button.

### RAMM Examples

Calculating the proper RAMM count for the desired selection is simple if you

remember that the system works by sensing the beginning of selections. It helps to visualize the sequence of selections on the tape as in the diagram below.

The following examples should help clarify RAMM operation:

1. You have just inserted a cassette which is fully rewound. You are, in other words, at point (A) on the tape. You wish to have the RAMM system find the beginning of the first selection, namely point (B). The required RAMM count is "1". Push the fast-forward button, immediately followed by two pushes of the pause button. (The first push of the pause button puts the deck into the cueing mode; the second push puts the deck into the RAMM mode with a "1" count.)
2. In the middle of selection 1, at point (C), you decide to jump ahead to selection 2, which is point (D). The required RAMM count is again "1". The procedure is the same as for example 1.
3. Before the end of selection 2, at point (E), you decide you want to hear selection 4, which starts at point (F). The required RAMM count is "2". You must press the pause button an extra time to obtain the desired count.
4. In the middle of selection 4, at point (G), you get an urge to go back and hear the tape from selection 2. In other words, you wish to go back to point (D). The required RAMM count is "3". This time, you must press the rewind button, followed by four pushes of the pause button.

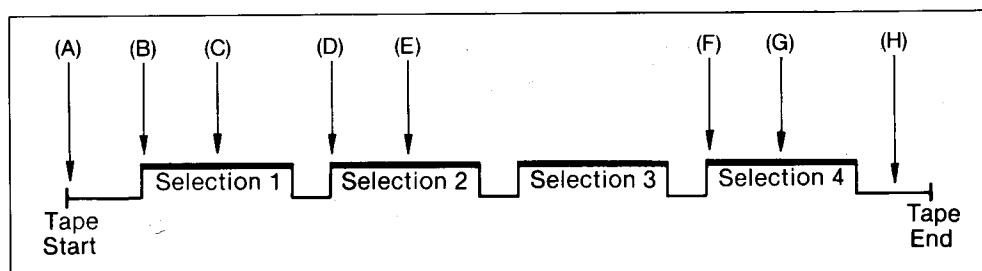

5. You have now heard the entire tape and are at point (H). You decide to hear the last selection 4 over again, so you want to return to point (F). The required RAMM count is "1". Push the rewind button once, followed by two pushes of the pause button.

**Note:**

- Always confirm your RAMM entries by observing the RAMM display.
- The RAMM display always shows the number of selections left to be skipped. If you should change the RAMM count in mid-search using the pause or record button, the system will skip the number of selections shown on the RAMM display.
- The pause button increases the RAMM count. The record button decreases the RAMM count.
- "9" is the maximum RAMM count. The RAMM display will not indicate anything higher, and the system will not recognize additional entries.

**Warning:** The RAMM system is not totally foolproof. The following conditions can and will induce erratic behavior.

- \* An interval of less than five seconds between selections.
- \* A natural pause in the music of more than five seconds.
- \* An extended pianissimo (low level) passage in the music.
- \* Low overall record level.
- \* Extraneous information, such as turntable rumble or hum, recorded between selections.

**Recommendations:**

- + Avoid going into the RAMM mode near the very beginning of a selection. Erroneous RAMM counts may otherwise result.
- + When making a recording for playback on your 670ZX, be sure to leave at least 5 seconds of silence between selections. This will help ensure proper RAMM operation. The temporary record mute function can be used effectively for this purpose.

## Temporary Record Mute Function

Temporary muting of the input signal while recording is possible by depressing the record button (10). Input signal is not recorded when the record button (10) is depressed while the tape is running, and the input signal resume to being recorded again when the record button is released.

As the monitor output will not be muted, input signals can be monitored when the monitor switch (15) is set to the "source" position, but not when set to "tape". This function enables to eliminate undesirable signal from recording, and to ensure the 5 seconds of silence interval between selections for proper RAMM operation.

## Remote Control

It is possible to operate the Nakamichi 670ZX from a remote location by using the optionally available remote control.

The RM-200 is remote control system which enables operation of the 670ZX from a distance of 5 meters (approx. 15ft.). The cable from the remote control unit plugs directly into the 670ZX's remote control socket (33).

All transport functions, including cueing and RAMM program search, can be performed with either remote control system.

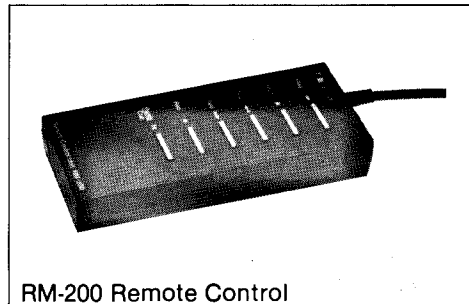

RM-200 Remote Control

## Nakamichi BlackBox Series Components

The 670ZX provides a rear panel connector which can be used to power one or more of Nakamichi's BlackBox Series accessories. The DC output jack (32) supplies a regulated  $\pm 10$  Volts DC and thus eliminates the need for the separate PS-100 Power Supply, which is normally used to power the BlackBox components. Although this jack can be used to power any Nakamichi BlackBox component, the following three have the greatest potential application for the 670ZX.

### MX-100 Microphone Mixer

Since the 670ZX has no built-in microphone preamplifiers, an external microphone mixer must be used for "live" recordings. The MX-100 provides three mic inputs (left, right and center "blend") with low noise and unusually wide dynamic range. It is particularly well-suited for applications of Nakamichi's tri-microphone live recording system. Nakamichi publishes a booklet on live recording, available on request, for those who wish to pursue the subject in further detail.

### SF-100 Subsonic Filter

If your preamplifier does not include a subsonic filter for the phono stage, you may occasionally experience a "fluttering" effect when recording warped records. If your turntable has excessive rumble, you may experience this effect rather frequently. Although it is best to prevent subsonic signals at their source, a good filter can "clean up" the sound considerably. The extended low frequency performance of the 670ZX makes it especially important that the input signal be free of extraneous subsonics. Lacking a subsonic filter in your preamplifier, you can add a Nakamichi SF-100 at the input of the 670ZX.



### LA-100 Line Amplifier

Although the 670ZX was designed to accommodate a wide range of amplifier input / output sensitivities, certain combinations may result in a mismatch. You may find the record output from your amplifier or receiver insufficient. Or your amplifier's tape input may lack sufficient sensitivity, making it difficult to achieve satisfying playback levels. The Nakamichi LA-100 can cure these and other mismatch problems.

The table below gives the maximum current consumption ratings for each of the BlackBox components. Refer to this table to calculate which and how many BlackBox units can be powered by the 680ZX. Under no circumstances connect BlackBox units exceeding 125mA in total current consumption. If you wish to use multiple BlackBox components which exceed 125mA in total current consumption, please purchase a PS-100 Power Supply. The instruction booklets supplied with individual BlackBox Series components should be consulted for additional information.

BlackBox Component	Current Rating
SF-100 Subsonic Filter	25 mA
LA-100 Line Amplifier	50 mA
BA-150 Bridging Adaptor	25 mA
MB-150 MC Booster Amp	100 mA
EC-100 Electronic Crossover	100 mA
MX-100 Microphone Mixer	50 mA

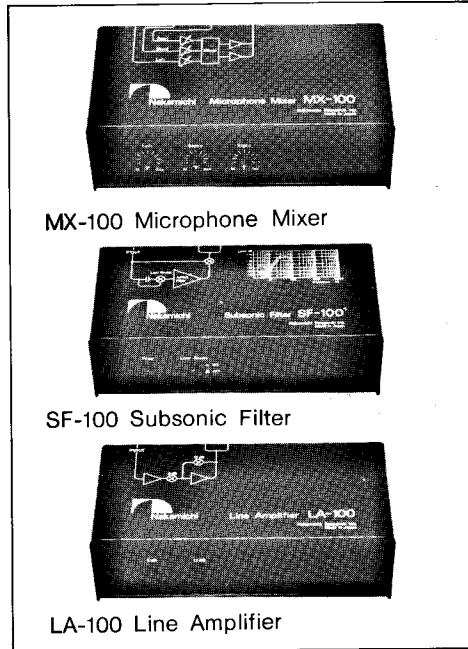

### Rack Mount Adaptor

A rack mount adaptor with carrying handle is attached to each side of the 670ZX. The 670ZX can thus be fitted into any 19" EIA standard rack. The adaptors can be easily removed, if so desired, by removing the screws which afix them to the 670ZX.

After removing the rack mount adaptors, fit the standard- accessory side panels with screws into the same holes.

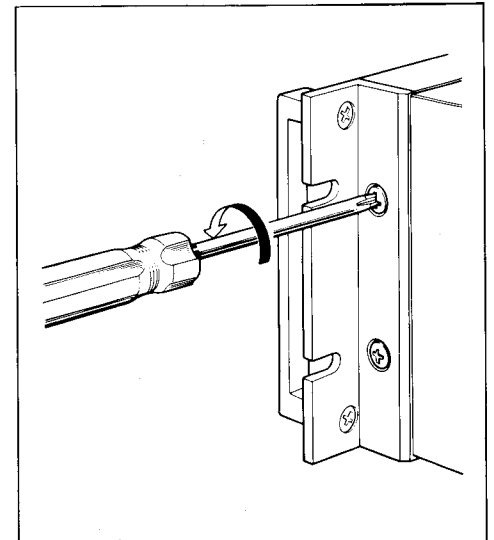

# Recommended Tape

Choosing a high quality recording tape is extremely important. A sophisticated cassette deck, like the 670ZX, cannot be expected to deliver superior performance with inferior tapes. The numerous brands and types of blank cassettes on the market vary not only in the consistency of the tape coating, but in the degree of mechanical precision as well. The performance of an otherwise excellent tape is often marred by a poor housing, which can result in skewing and other unsteady tape travel conditions.

Nakamichi offers several premium quality cassettes manufactured to the strictest tolerances. These cassettes are used at the Nakamichi factory for final

adjustments to the decks. Nakamichi cassettes are what enable Nakamichi to guarantee cassette deck specifications. In addition to offering these reference-grade cassettes, Nakamichi maintains a sampling program to evaluate the performance of the market's most popular cassettes. The table below lists those cassette tapes which are acceptable by Nakamichi's standards. Brands other than Nakamichi are listed in alphabetical order. Since this list is subject to constant updating, we recommend you periodically write to Nakamichi to obtain the most recent test results. Nakamichi does not recommend the use of C-120 or ferrichrome cassettes under any circumstances.

## Tape and Eq Switch Settings

The Tape and Eq selector switches on the 670ZX permit you to choose from a variety of tape formulations. The Tape switch selects the proper bias and record sensitivity for each cassette type. The Eq switch gives you a choice of record and playback equalizations to optimize conditions for the type of tape in use and the nature of the program material to be recorded.

**Bias** is an inaudible high frequency signal used to reduce the non-linearities and distortions inherent in the magnetic recording process. Bias is applied only during record, and, hence, the Tape selector has no effect during playback. Low-noise/high-output ferric oxide (or modified ferric oxide) formulations, like Nakamichi EX-II require a certain bias level, sometimes termed "normal". Chromium dioxide and chrome-equivalent tapes, such as Nakamichi SX, require approximately 45% more bias. Metal tape formulations, such as Nakamichi ZX, require almost twice the bias of chrome-equivalents for distortion-free recording. Your Nakamichi 670ZX has been factory adjusted for Nakamichi EX-II, SX and ZX tapes in each of the respectively marked Tape switch (20) positions. The other recommended tapes are closely compatible in their respective categories.

**Equalization** is used in record and playback to achieve optimum signal-to-noise and headroom performance for different tape formulations. Like bias, the proper Eq switch (19) setting must be selected for each type of tape. Unlike bias, the Eq switch must be set for both record and playback. Normally, you would set the Eq switch according to the table, but the excellent high frequency performance of the Nakamichi 670ZX permits unusual settings of the Eq switch for special purposes:

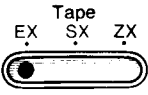
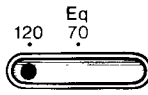
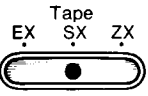
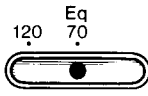
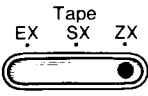
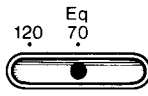
Tape Selector Settings	Recommended Eq Setting	Brand	Formulations
		Nakamichi Ampex Fuji Maxell TDK	EX, EX-II Grand Master I FX-I UD, UDXL-I AD
		Nakamichi Ampex Fuji Maxell TDK	SX Grand Master II FX-II UDXL-II SA
		Nakamichi Others*	ZX

\*Most major tape manufacturers will be offering a metal formulation in 1979. Lack of specific test data prevents listing by brand at this writing. Write to Nakamichi for up-to-date information regarding metalloy cassettes.

- (A) If you wish to make a recording on SX-type or ZX-type tape for someone who does not have 70  $\mu$ sec equalization (sometimes labeled the "CrO<sub>2</sub>" or "chrome" position) on his cassette deck, record with the Tape switch (20) in the recommended position but the Eq switch (19) in the 120  $\mu$ sec position.
- (B) Occasionally, you may encounter program material with an unusually high amount of energy at higher frequencies. (Some synthesizer music fall into this category.) In such instances you may wish to record on SX-type or ZX-type tape with the Eq switch (19) in the 120  $\mu$ sec position rather than the recommended 70  $\mu$ sec position. This will result in 3—4 dB higher noise, but high-frequency saturation will be commensurately reduced. Be sure to make note of the special equalization on the cassette label and to play back with the 120  $\mu$ sec equalization.
- (C) Some program material may make large dynamic range demands at mid-frequencies but with comparatively little high-frequency content. In such instances you can take advantage of the 70  $\mu$ sec equalization, even with an EX-type tape, which normally uses 120  $\mu$ sec. If you record on an EX-type tape with the 70  $\mu$ sec Eq, you will be giving up a certain amount of high-frequency overload margin but gaining 3—4 dB of signal-to-noise ratio. As above, make note of the special equalization and be sure to play the cassette with the 70  $\mu$ sec Eq setting.

# Record Head Auto Azimuth Alignment and Record Calibration

## Record and Playback Process

As the 670ZX adopts the system of wide-gap recording and narrow-gap playback, independent heads are used for erase, record and playback to bring out the maximum performance of metal-position tapes (Nakamichi ZX tape, and the like). The record/playback process, which is illustrated in the block diagram shown at the right, adopts the after-monitor system in which the recorded signals can be immediately played back by changing over the monitor switch.

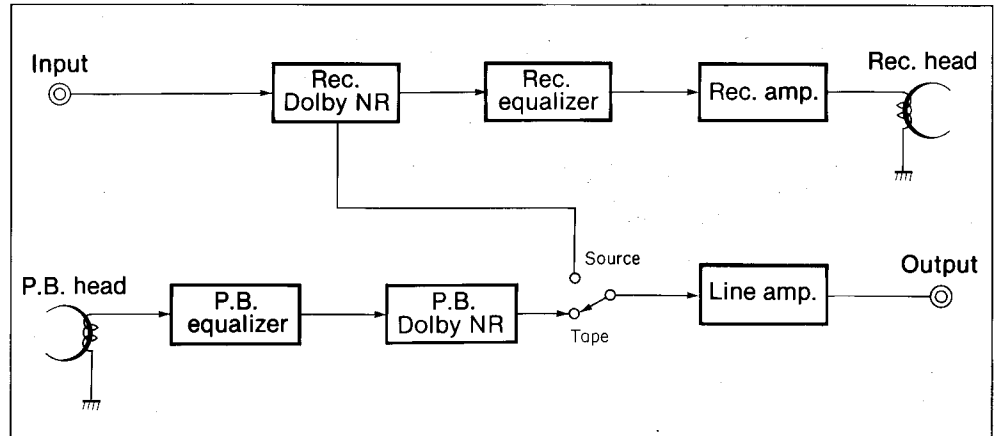

## Record Head Auto Azimuth Alignment

Azimuth is the degree to which the gap of a magnetic head is perpendicular to the path of tape travel. As the cassette tape travels in its state accommodated in the cassette half (housing), the perpendicular angle (azimuth) of the record and playback heads may change depending on the formed condition of the housing, causing degradation of high-frequency response. This is known as azimuth loss. The 670ZX is equipped with an auto azimuth alignment mechanism to enable automatic alignment of the azimuth for each different tape in use. This mechanism performs automatic alignment of the record head azimuth, by recording the built-in 400Hz test tone and using it to detect the phase difference between the L-ch and R-ch at the playback head. As this alignment can be achieved both accurately and speedily, we suggest you do it and confirm proper alignment before recording. Auto azimuth alignment is to be performed before recording, using the tape to be used in it. Therefore, this alignment should be performed for each cassette tape, and whenever changing the same tape over from side A to side B.

## Record Calibration

The Dolby Noise Reduction System, in short, is a system that functions to eliminate the noise of the treble range. Because of the complex operating mechanism of the system, characteristics that can be normally obtained with the system cannot be expected, unless proper record calibration has been performed before recording. If the same type of tape is being used, there is no need to calibrate. However, record calibration must be performed whenever a different type of tape is to be used. Similar to "Record Head Auto Azimuth Alignment", adjustments are to be made using the built-in 400Hz test tone. Therefore, begin by performing azimuth alignment and then proceed to record calibration.

### Note:

— In the case the monitor switch is positioned to "tape" during record head auto azimuth alignment, the peak level meters will give no display even when the 400Hz test tone is being recorded. However, as soon as azimuth alignment has been completed, the peak level meters will start display again.

## Record Head Auto Azimuth Alignment and Record Calibration Procedures

- (A) Load the cassette tape you intend to use, and fast-forward the tape a little.
- (B) Set the tape switch and Eq switch (19, 20) according to the tape in use. See page 15 for recommended settings.
- (C) Set the Dolby NR/MPX filter switch (18) to the "out" position.
- (D) Set the Auto. A/Tone switch (17) to "Cal".
- (E) Adjustments are to be started from the azimuth alignment. Set the monitor switch (15) to the "source" position. When in this mode, the oscillator will oscillate the 400Hz test tone and the peak level meters will indicate "0dB".

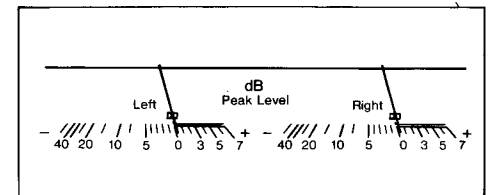

- (F) Set the monitor switch (15) to the "tape" position.
- (G) While depressing the record button (10), depress the play button(7) to start recording.

(H) This will activate the auto azimuth alignment mechanism. During alignment, the play button lamp will keep flashing, indicating that alignment is in progress.

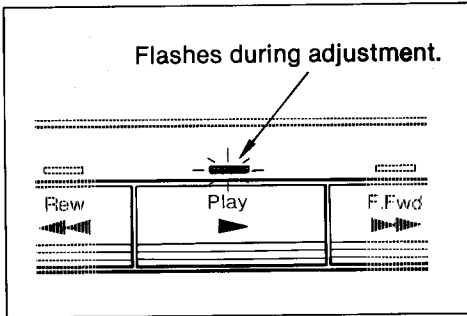

**Note:**

While the lamp is flashing, the peak level meters of the 670ZX will be muted and no display will be made.

- (I) Auto azimuth alignment will be completed in several seconds. This will cause the play button lamp to stop flashing and to be kept in a continuously illuminated state. At the same time, the peak level meters will start to display the after-monitored test tone.
- (J) While continuing recording of the 400Hz test tone, record calibration is to be performed.
- (K) With the monitor switch kept position to "tape" and the Auto. A/Tone switch to "Cal", adjust the 670ZX in the following manner. If the reading of the display of the peak level meters are on the "minus" side below

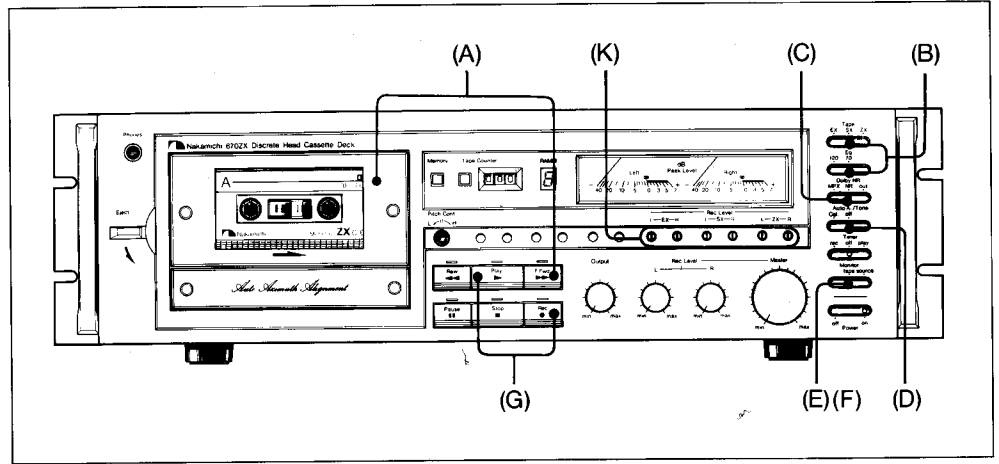

"0dB", gradually turn the rec cal controls (L & R) clockwise, using the standard-accessory screwdriver provided for adjustment so as to make the display for both L and R read "0dB". If the reading of the meter display is on the "plus" side above "0dB", turn the controls counterclockwise and adjust it in the same manner.

- (L) With this, you have completed auto azimuth alignment and record calibration for the tape to be used for recording. Switch off the Auto. A/Tone switch.

**Note:**

- The rec cal controls will only be effective when the test tone is being recorded and the monitor switch is positioned to "tape". In this case, the result will be displayed on the peak level meters. In other cases, such as when in the playback mode or the monitor switch is positioned to "source", the rec cal controls will have no effect.
- If, in the record calibration steps (J) or (K), the level was found to deviate by -5dB, or more from "0dB" and alignment was performed, switch off the Auto. A/Tone once and then set it to "Cal" again to carry out record head auto azimuth alignment. This is necessary because positive azimuth alignment may not have been achieved in the case the level is lower by 5dB, or more.

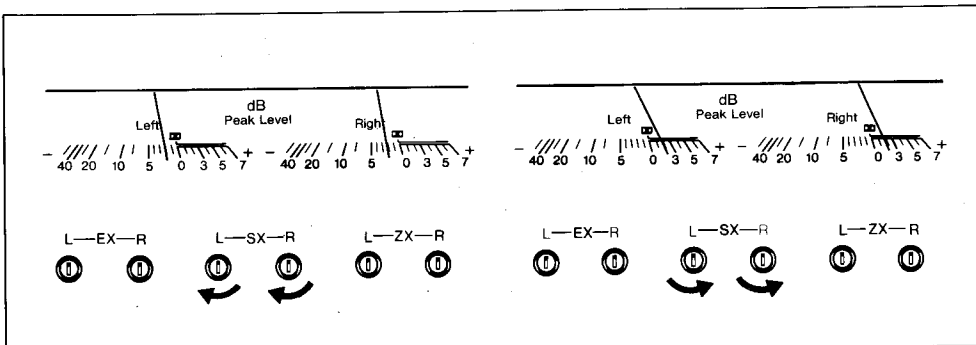

# The Dolby System

## What it will and will not do

The Dolby Noise Reduction circuits of the 670ZX reduce the hiss inherent in the tape recording process. The Dolby system cannot reduce the noise of your source material. If your records, FM broadcasts, microphones, and other sources are noisy, the cassette deck's Dolby system will not improve them. But the Dolby system will reduce tape noise by as much as 10dB.

The Dolby system has an encode (record) and a decode (playback) process. Dolby-encoded cassettes should be labeled as such; when played back without the proper Dolby decoding, they will sound unnaturally "bright". Conventional (non-Dolby-encoded) cassettes will sound unnaturally "dull" when played back with Dolby decoding. This boosting and cutting of the high frequencies has much to do with how Dolby Noise Reduction is accomplished.

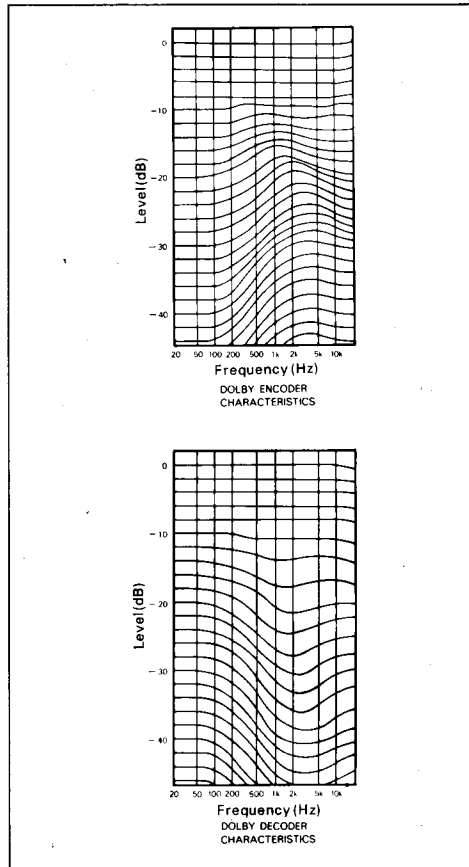

## How the system works

The Dolby encoder boosts the high-frequency program content before it goes onto the tape. The Dolby decoder gives the high frequencies equal and opposite treatment during playback. While the decoder returns the high-frequency content to original levels, it simultaneously reduces the high-frequency noise incurred in the recording process.

Because noise is more noticeable during quiet passages than during loud passages, the Dolby system does not treat all high frequency signals equally. It gives more of a boost to low-level high-frequency signals than it does to high-level high-frequency signals. This variation of the Dolby system's effect across the dynamic range distinguishes Dolby Noise Reduction from simply "turning up the treble" on record and "turning down the treble" on playback. "Turning the treble" up and down is, in fact, the basic idea behind tape record and playback equalization, RIAA phono equalization, and FM pre-emphasis/de-emphasis. All of these systems involve boosting the high frequencies at one end and equal reduction of high frequencies at the other. All work to reduce noise. But the amount of boosting in each case is limited by the headroom characteristics of the medium. In the case of tape recording, too much equalization (too strong a high-frequency boost) will saturate the tape and distort the recording. Hence there is a limit to the amount of noise reduction attainable through equalization alone. FM pre-emphasis and phono equalization face similar limitations.

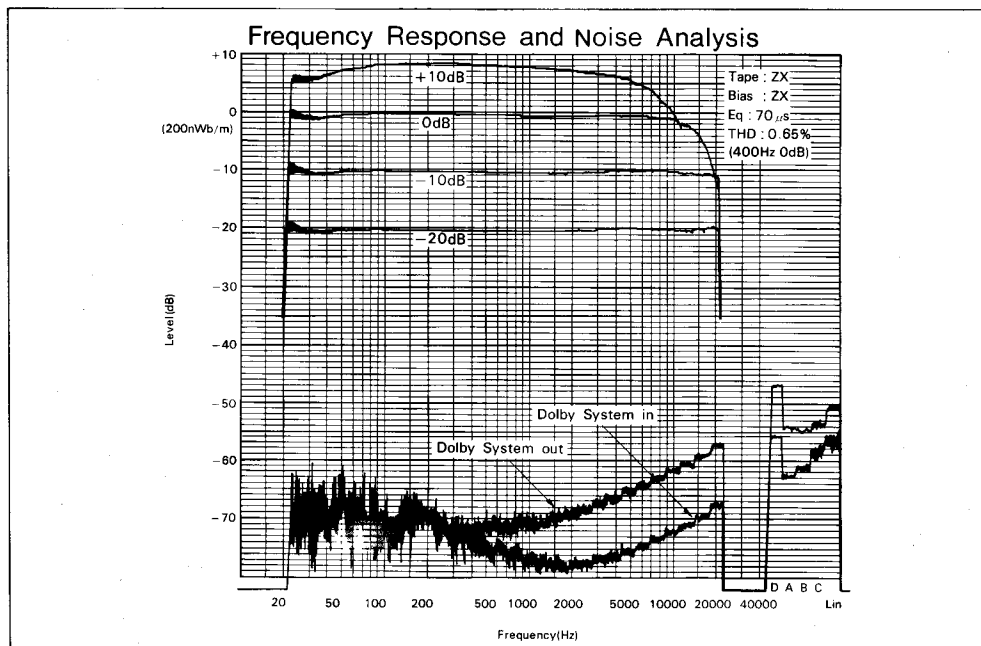

The Dolby Noise Reduction system does not, because the Dolby system only boosts low-level signals. This provides an additional 10 dB of noise reduction without threatening the headroom of the medium.

### Why is level calibration necessary?

The “rec cal” controls of the Nakamichi 670ZX are used in conjunction with the 400Hz reference test tone. The adjustment assures that a tone recorded at 0dB will play back at 0dB. Although tape formulations of the same category (page 15) pose the same equalization requirements, variations in tape sensitivity will cause one formulation to provide more output than another formulation. The controls permit you to adjust the deck for the sensitivity of each formulation you use.

Without calibration, the Dolby circuits could potentially mis-track on different formulations. Recording on a more sensitive formulation without recalibrating would mean that a test tone recorded at 0 dB would play back at higher than 0 dB. The Dolby decoder would fail to provide the full high frequency cut, and the tape would sound slightly “bright” on playback. Conversely recording on a less sensitive tape without recalibrating would produce slightly “dull” playback. Level calibration is essential for Dolby system compatibility from cassette to cassette.

# Maintenance

## Head and Transport Cleaning

To maintain the Nakamichi 670ZX's superior performance and to prolong the life of the heads and pressure rollers, all parts that come into contact with the tape should be cleaned frequently and thoroughly. Dirty heads, capstans or pressure rollers may result in any of the following symptoms:

- Uneven sound levels.
- Loss of high frequencies.
- Wow and flutter.
- Damage to cassette tapes.
- Tape squeal caused by excess friction.

Even the best cassettes shed particles onto the heads, capstans and pressure rollers. Clean a minimum of once every ten hours of use, even if you use premium tapes. If you must use inferior brands of tape, you may need to clean after each playing. By observing the amount of contamination accumulated on the cleaning stick pad or cotton tip, you will be able to judge whether you are cleaning the 670ZX frequently enough. Repeated cleanings, if properly done, will not harm the deck. Hence, it is impossible to clean too often.

A Cleaning Kit consisting of a plastic stick, sponge tips, cotton tipped sticks and a container of alcohol is supplied with your Nakamichi 670ZX. When the alcohol runs out, use commercially available isopropyl alcohol (preferably undiluted). "Q-tips" and other cotton swabs may be used in the place of the sponge tips. Do not, however, rely on head cleaning cassettes. Some head-cleaning cassettes are unduly abrasive and may damage the heads. None of them clean the capstans and pressure rollers properly. Perform all cleaning with alcohol. Use the plastic stick with a sponge tip screwed onto its end. A cotton-tipped stick is equally effective, but be careful not to leave strands of cotton on any of the cleaned parts.

- (A) Turn the power switch (14) on. Remove the acrylic cassette holder cover by unscrewing the two hand-screws on the front of the holder (1).

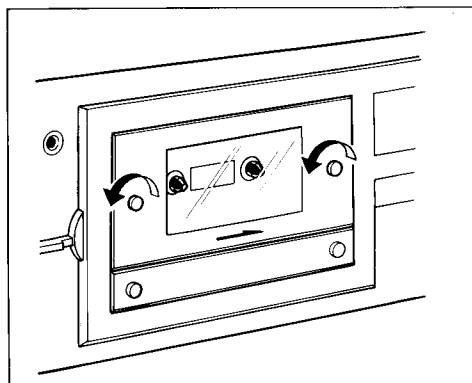

- (B) With a cleaning stick dipped in alcohol, clean the surfaces of the record/playback and erase heads. Clean with short, firm back-and-forth strokes along the path of tape travel. Also be sure to clean the tape guide on the far left.

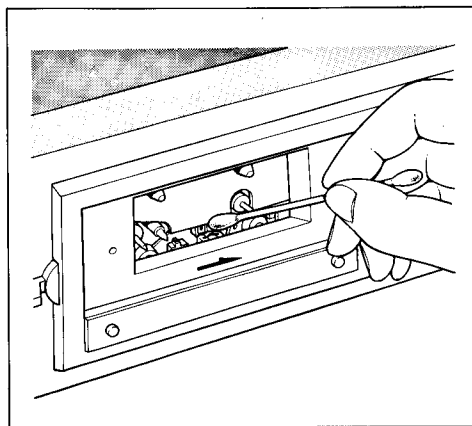

- (C) Press the play button (7). Carefully apply the cleaning stick to one pressure roller as it turns. Use light pressure and an up-and-down stroke to cover the entire width of the roller. Repeat with the other pressure roller. If you are using a cotton-tipped stick, make sure to apply the tip to the side of the roller rotating away from the capstan; the

cotton may otherwise get caught between the capstan and the roller. (If this should happen, simply press the stop button and remove the cotton.)

- (D) With the transport in the stop mode, apply a clean section of the cleaning stick pad to one capstan. Move the pad up and down the capstan shaft as it turns. Repeat with the other capstan.
- (E) Press the eject button, and carefully replace the acrylic cover.

Cleaning is now completed, but give the cleaned surfaces a minute or two to dry off completely before playing a tape.

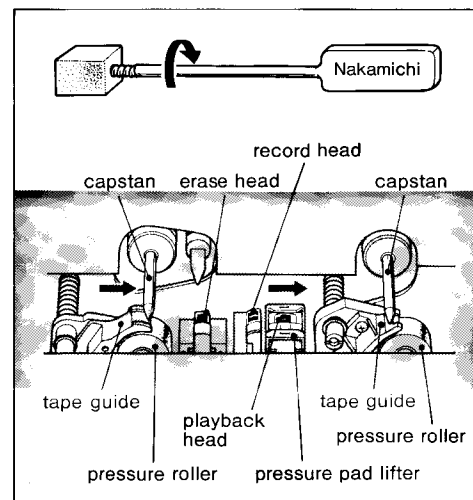

- Tape guide and heads are critically aligned at the factory. Do not exert too much pressure on these parts. It is better to stroke repeatedly than to stroke forcefully.
- Do not flood various parts with cleaning alcohol. After dipping the stick into alcohol, squeeze off any excess.
- Be sure to remove any cotton strands from the cleaned parts.



## Demagnetizing

All metal parts that come into contact with the tape must be occasionally demagnetized to prevent the build-up of residual magnetism. Such magnetism can add hiss to a tape being played and partially erase the high frequencies. Although the heads and capstans of Nakamichi cassette decks require demagnetizing less frequently than those of most other cassette decks, you should nevertheless demagnetize once every 50 hours of use to be on the safe side.

The Nakamichi DM-10 Demagnetizer is recommended since it has been specifically designed for cassette decks, but any properly designed demagnetizer will do.

- (A) Remove all tape from the vicinity of the tape deck before proceeding. Make sure the 670ZX's power switch (14) is off. Remove the cassette holder cover (1).
- (B) Turn the demagnetizer on while it is at least two feet away from the deck. Slowly bring the tip as close as possible to the playback head. Do not make contact with the head unless the tip of the demagnetizer is covered with vinyl or rubber to prevent scratching the head's surface. A piece of vinyl tape may be used to cover the tip if it is not already covered.

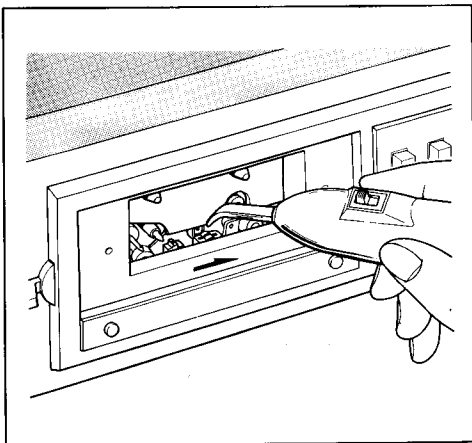

- (C) Move the demagnetizer slowly in a random pattern about the surface of the head for at least 10 seconds. Move it slowly to the record head and repeat the random pattern. Then, move the demagnetizer to one capstan then the other, repeating the random pattern for 10 seconds. (It is not necessary to demagnetize the erase head.)
- (D) After demagnetizing the capstans, slowly withdraw the demagnetizer from the deck. Wait until the demagnetizer is at least two feet from the deck before turning the demagnetizer off. Never turn it off while it is close to a head or capstan as this may semi-permanently magnetize the part.

## Lubrication

The moving parts of the Nakamichi 670ZX transport are fitted with oil-less bearings. periodic lubrication is not necessary.

## Cleaning the Faceplate

Remove dust or smudges with diluted detergent applied with a soft-cloth. Never use solvents, ammonia, or abrasive cleaning agents.

## Head Height and Azimuth

The head height and azimuth adjustments of the Nakamichi 670ZX are calibrated at the factory for optimum performance. Readjustment should only be done by qualified service technicians. The only exception to this is record head azimuth.

## Repairs

Your Nakamichi 670ZX has been designed for long service life. Should your 670ZX require servicing, please consult your Nakamichi dealer or the Nakamichi dealer nearest you. As there are no user-serviceable parts inside the unit, please do not attempt your own repairs.

# Troubleshooting

Condition	Probable Cause	Remedy
Tape does not run.	<ol style="list-style-type: none"><li>1. Power cord is unplugged.</li><li>2. Tape is loose inside cassette.</li><li>3. Cassette is not properly seated.</li></ol>	Plug in cord firmly. Wind tape up. Eject and re-insert cassette.
Cannot record.	<ol style="list-style-type: none"><li>1. Input disconnected.</li><li>2. Head dirty.</li><li>3. Cassette tabs have been removed.</li></ol>	Check connections. Clean head. Place adhesive tape over tab opening or use new cassette.
Cannot playback.	<ol style="list-style-type: none"><li>1. Output disconnected.</li><li>2. Dirty head.</li></ol>	Check connections. Clean head.
Excessive playback hiss.	<ol style="list-style-type: none"><li>1. Head is magnetized.</li><li>2. Recording volume is too low.</li></ol>	Demagnetize head. Adjust recording levels.
Distorted record/playback sounds.	<ol style="list-style-type: none"><li>1. Program material is itself distorted.</li><li>2. Recording levels are too high.</li><li>3. Excessive FM carrier leak.</li></ol>	Check program material. Adjust recording levels. Set the Dolby NR switch to the "MPX" position when Dolby system is used.
Unsteady tape travel.	<ol style="list-style-type: none"><li>1. Capstan and/or pressure roller dirty.</li><li>2. Tape packing inside cassette faulty.</li></ol>	Clean these parts. Replace cassette.
Incomplete erasure.	Erase head is dirty.	Clean head.
Weak high frequencies.	<ol style="list-style-type: none"><li>1. Dirty heads.</li><li>2. Magnetized head.</li><li>3. Improper bias level for tape.</li></ol>	Clean heads. Demagnetize head. Check tape selector switch position.
Hum heard during record or playback.	<ol style="list-style-type: none"><li>1. Induction fields near deck.</li><li>2. Signal cable grounding faulty.</li></ol>	Keep deck away from amplifier, transformers, fluorescent lamps, etc. Replace signal cables.
Sounds rumble when recording is made from a record disc.	Rumbling of record disc.	Use (optional accessory) subsonic filter SF-100.

## Specifications

Power Source .....	100, 120, 120/220-240, 220 or 240V; 50/60 Hz (according to country of sale)
Power Consumption .....	27W Max.
Tape Speed .....	1-7/8 ips. (4.8cm/sec.) $\pm$ 0.5%
Frequency Response .....	10-22,000Hz $\pm$ 3dB (@-20dB rec level, ZX tape)
Signal-to-Noise Ratio .....	Better than 66dB (IHF-A WTD RMS, ref. 400Hz, 3% THD, w/Dolby NR, ZX tape, 70 $\mu$ sec EQ)
Total Harmonic Distortion.....	Less than 0.8% at 400Hz, 0dB w/ZX tape Less than 1.0% at 400Hz, 0dB w/SX, EX-II tapes
Wow-and-Flutter.....	Less than 0.08% WTD peak, 0.04% WTD RMS
Erasure .....	Better than 60dB below saturation level at 1kHz
Separation .....	Better than 37dB at 1kHz, 0dB
Crosstalk .....	Better than 60dB at 1kHz, 0dB
Bias Frequency.....	105kHz
Input.....	50mV, 50k ohms
Output .....	1V (400Hz, 0dB, output control at max.) 2.2kohms
Headphone Output .....	45mW (at 400Hz, 0dB, 8 ohms)
DC Output Jack .....	$\pm$ 10V DC, 125mA max.
Dimensions .....	482(W) $\times$ 143(H) $\times$ 340(D) millimeters 19(W) $\times$ 5-5/8(H) $\times$ 13-3/8(D) inches
Approximate Weight .....	9kg. 19lb. 13oz

- Specifications and appearance design are subject to change for further improvement without notice.
- Dolby NR under license from Dolby Laboratories.
- The word "DOLBY" and the Double-D-Symbol are trademarks of Dolby Laboratories.

## Optional Accessories

ZX Cassette Tape C-60, C-90  
SX Cassette Tape C-60, C-90  
EXII Cassette Tape C-60, C-90  
EX Cassette Tape C-60, C-90

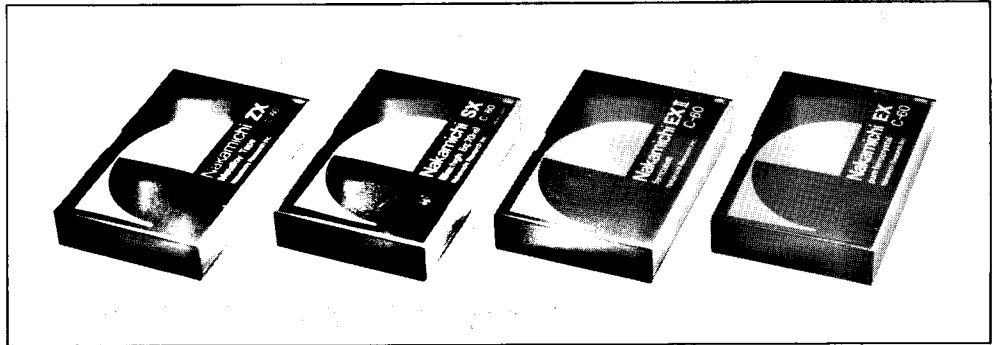

MX-100 Microphone Mixer

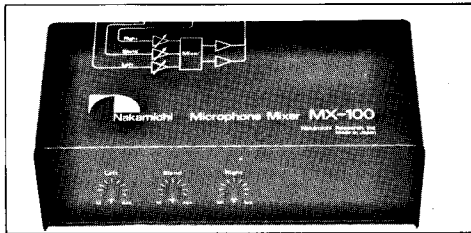

SF-100 Subsonic Filter

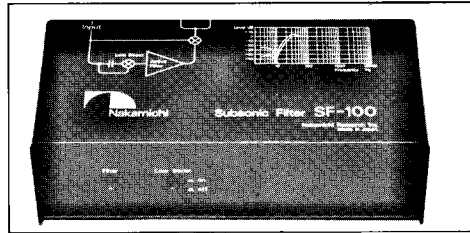

LA-100 Line Amplifier

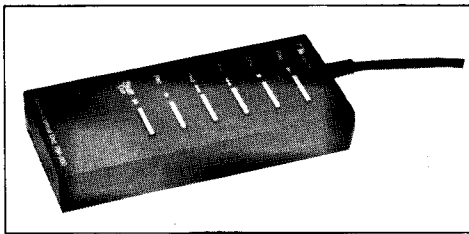
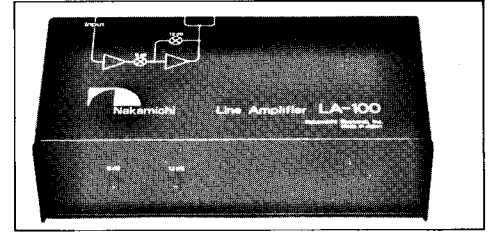

RM-200 Remote Control

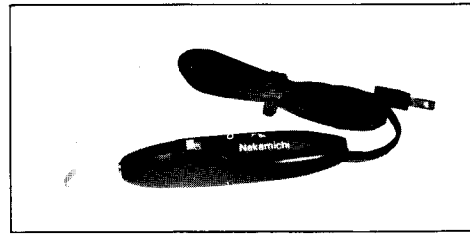

DM-10 Head Demagnetizer

## Nakamichi Corp.

1-153 Suzukicho, Kodaira, Tokyo  
Phone: (0423) 42-1111  
Telex: 2832610 (NAKAM J)  
Cable: NAKAMICHI KOKUBUNJI

## Nakamichi U.S.A. Corp.

220 Westbury Avenue  
Carle Place, N.Y. 11514  
Phone: (516) 333-5440  
Telex: 144513 (NAKREI CAPL)

## Nakamichi U.S.A. Corp.

1101 Colorado Avenue  
Santa Monica, Calif. 90401  
Phone: (213) 451-5901  
Telex: 652429 (NAKREI SNM)